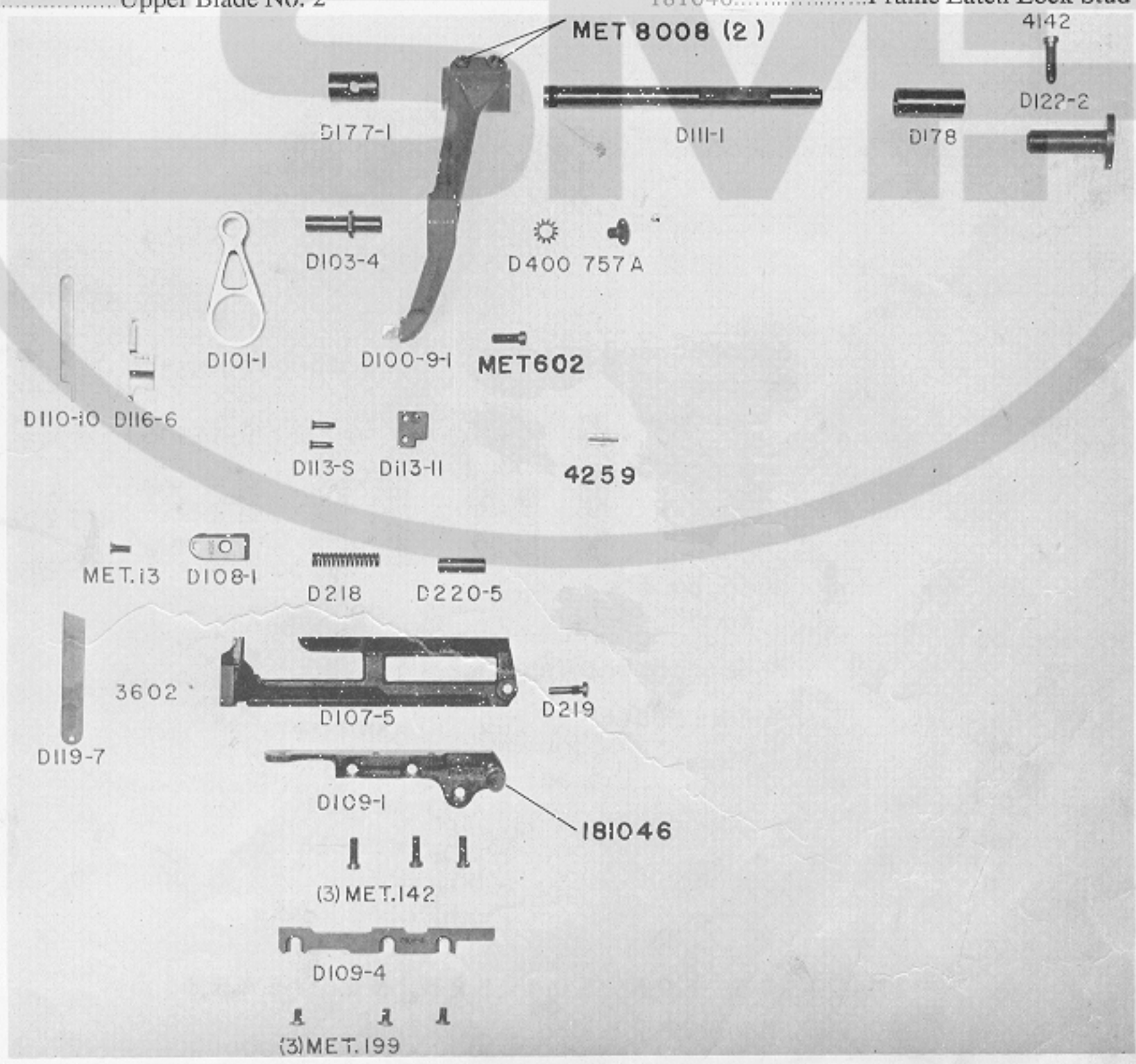

FIG. 1

UPPER & LOWER TRIMMER ASSEMBLY

- D100-9-1..... Trimmer Arm
- MET 8008..... Trimmer Arm Screws (2)
- D101-1..... Trimmer Arm Connection
- D103-4..... Trimmer Arm Connection Stud
- 757-A..... Trimmer Arm Connection Stud Screw
- D400..... Trimmer Arm Connection Stud Screw Washer
- D111-1..... Trimmer Arm Shaft
- D178..... Trimmer Arm Shaft Bushing, Right
- D177-1..... Trimmer Arm Shaft Bushing, Left
- D122-2..... Trimmer Arm Shaft Positioning Stud
- 4142..... Trimmer Arm Shaft Positioning Stud Set Screw
- D113-11..... Upper Blade Strap
- 4259..... Upper Blade Strap Shoe Pin
- D113-S..... Upper Blade Strap Screws (2)
- D110-10..... Upper Blade No. 2

- D116-6..... Upper Blade Clamp Shoe
- MET 602..... Upper Blade Clamp Screw
- D107-5..... Lower Blade Holder (Wide Blade)
- 3602..... Lower Blade Clamp Steady Pin
- D109-1..... Lower Blade Holder Guide
- MET 142..... Lower Blade Holder Guide Screws (3)
- D109-4..... Lower Blade Holder Gib
- MET 199..... Lower Blade Holder Gib Screws (3)
- D220-5..... Lower Blade Holder Plunger
- D218..... Lower Blade Holder Plunger Spring
- D219..... Lower Blade Holder Plunger Stop Screw
- D108-1..... Lower Blade Clamp (Wide Blade)
- MET 13..... Lower Blade Clamp Screw
- D119-7..... Lower Blade (Wide)
- 181046..... Frame Latch Lock Stud



"SUPERLOCK" MACHINE

PLAIN FEED PARTS

D261-1.....	Feed Surface Shank—Single Feed Only	D127-2.....	Feed Bar Shaft
MET 8008-L.....	Feed Surface Shank Tilt Screw	757-A.....	Feed Bar Shaft Plug Screw
D261-P-1.....	Feed Surface Shank Plate	181099.....	Stitch Regulating Connection Washer (Rear)
MET 602.....	Feed Surface Shank Screws (2)	181093.....	Stitch Regulating Connection
D131-1.....	Feed Lift Eccentric Block (Pair)	441003.....	Frame Check
D133-1.....	Feed Bar Guide, Left	D16.....	Frame Check Pivot Stud
D132-2.....	Feed Bar Guide, Right	D361.....	Needle Shield
D126-2.....	Feed Bar Cap	MET 222.....	Needle Shield Screw Washers (2)
MET 1007-D.....	Feed Bar Cap Screws (2)	MET 233.....	Needle Shield Screws (2)
D125-2.....	Feed Bar	MET 96.....	Feed Bar Guide Screws (4)
MET 8008-L.....	Feed Bar Shaft Screw	MET 34.....	Feed Surface, Back Screw
D128-1.....	Feed Rocker	D352-2.....	Feed Surface Shank Opening Shield
MET 8008.....	Feed Rocker Screws (2)	MET 112-S.....	Feed Surface Shank Opening Shield Screw
D130-1.....	Feed Rocker Shaft Bushings (2)	181097.....	Stitch Regulating Stud
MET 8008-L.....	Feed Rocker Shaft Bushing Screws (2)		
D129-1.....	Feed Rocker Shaft		

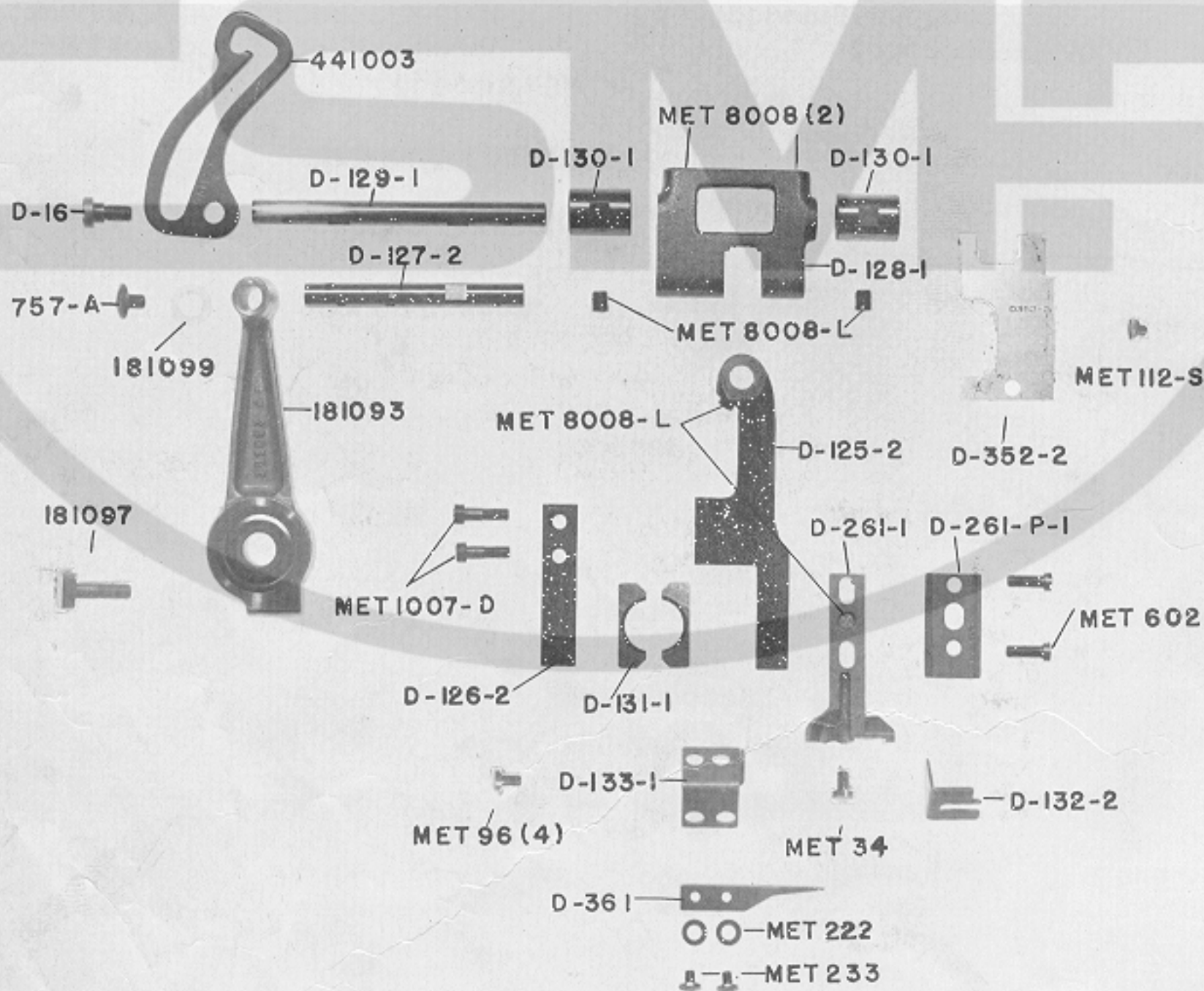

SWING-OUT FOOT CARRIER

181007.....	Foot Carrier	D175.....	Foot Carrier Arm Stop Screw
181009.....	Foot Carrier Screw	MET 74.....	Foot Carrier Arm Stop Screw Nut
181017.....	Foot Carrier Hinge Pin	D179-2.....	Foot Carrier Arm Tension Screw
181011.....	Foot Holder	D173.....	Foot Carrier Arm Tension Spring
181009.....	Foot Holder Screw	D174.....	Foot Carrier Arm Tension Spring Buttons (2)
182036.....	Foot Shoe Tilt Wire	D359-A.....	Foot Carrier Arm Shaft
MET 229.....	Foot Shoe Tilt Wire Screw	181006.....	Foot Carrier Complete (Incl. 181007, 181008, 181009 (2), 181010, 181011, 181012, 181013, 181016, 181017, D175, D179-2, MET 74)
181010.....	Foot Carrier Hinge	D177-1.....	Foot Carrier Arm Shaft Bushing, Left
181019.....	Foot Carrier Hinge Pin Set Screw	D178.....	Foot Carrier Arm Shaft Bushing, Right
181013.....	Foot Carrier Lock		
181008.....	Foot Carrier Arm		
MET 8008.....	Foot Carrier Arm Screw		
181012.....	Foot Carrier Lock Lever		
181019.....	Foot Carrier Lock Lever Set Screw		
181016.....	Foot Carrier Lock Lever Spring		

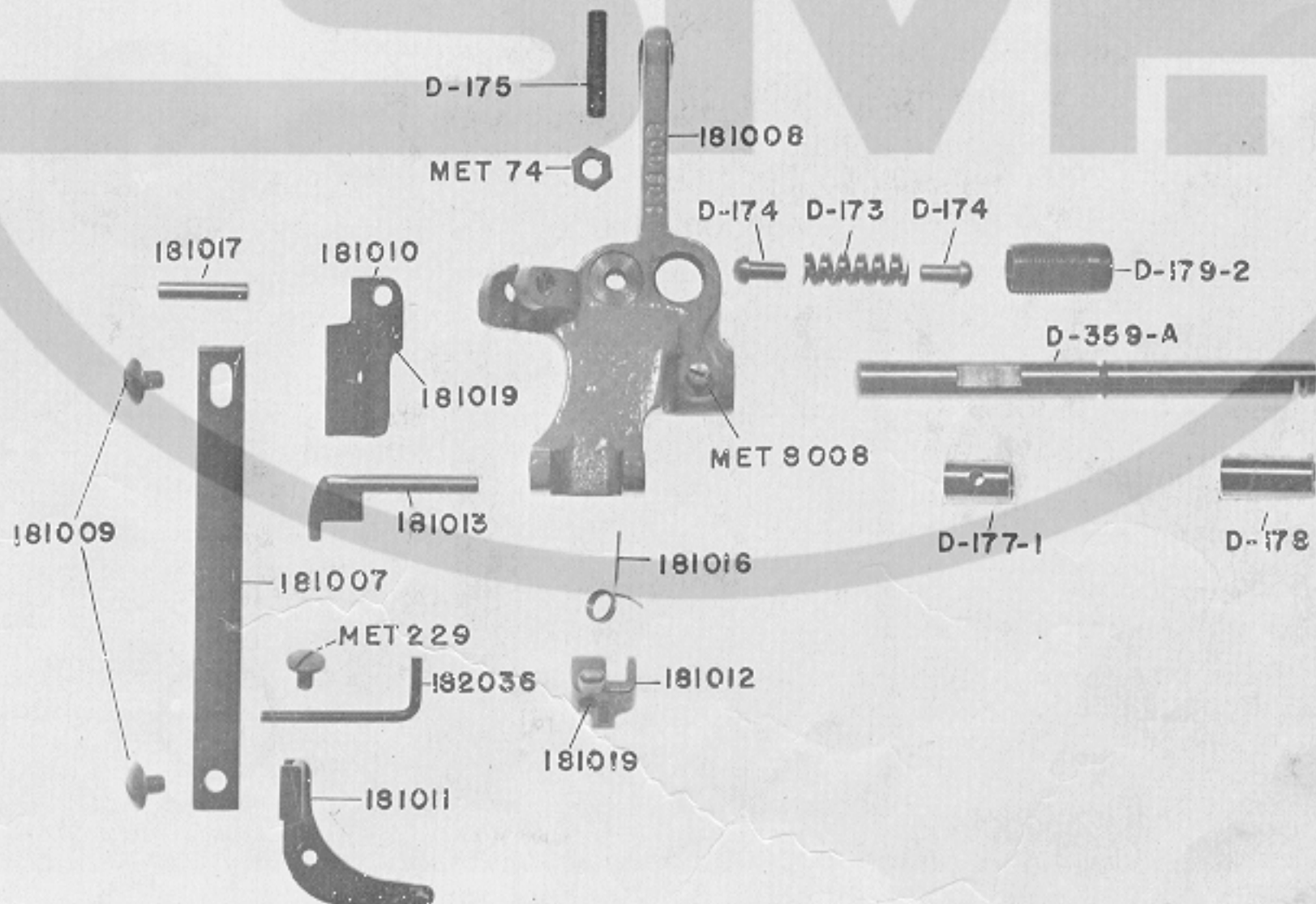

"SUPERLOCK" MACHINE

OIL PUMP AND LUBRICATION PARTS

- 181083.....Oil Pump Complete (Incl.
181081, MET 61 (4), 181076,
181060, MET B217, 181062,
MET B218-W, MET B226,
MET H7-1)
- 181085.....Oil Strainer
- 181080.....Oil Filter
- 181086.....Base Window
- D193.....Oil Gauge Glass
- D195-3.....Oil Valve Plate No. 3 Complete
- MET 233.....Oil Valve Plate Screw
- MET B229.....Oil Pump Set Screw

- 181063.....Oil Pump Pulley
- MET 8008-L.....Oil Pump Pulley Screw
- 181060.....Oil Pump
- 181062.....Oil Pump Shaft
- MET B218-W.....Oil Pump Pinion Washer
- MET H7-1.....Oil Pump Gear
- MET B217.....Oil Pump Idler Gear Pin
- MET B226.....Oil Pump Gear Washer
- 181081.....Oil Pump Cover Wear Plate
- 181076.....Oil Pump Cover
- 181082.....Oil Pump Intake Gasket
- MET 61.....Oil Pump Cover Screws (4)

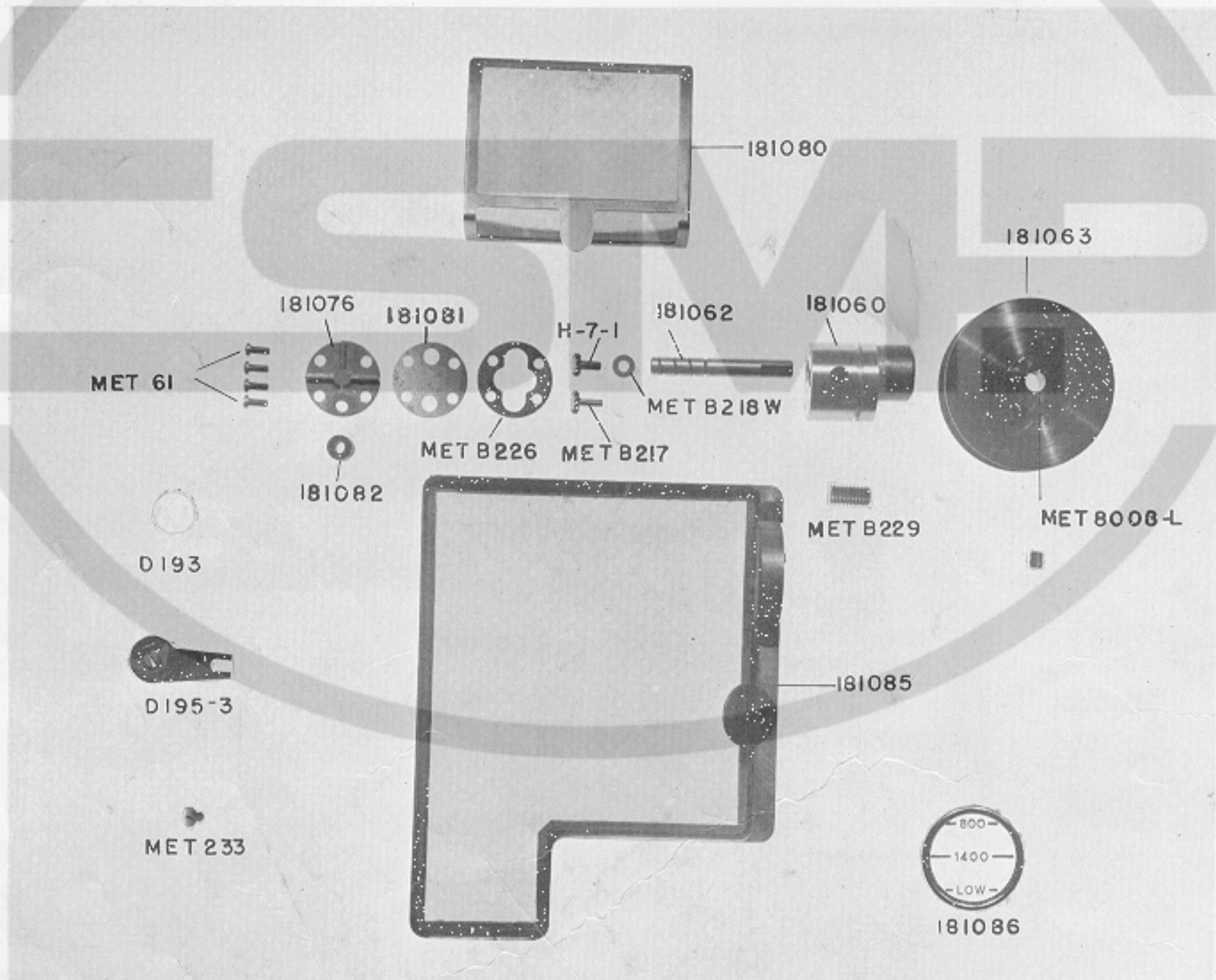

MACHINE MOUNTING & FOOT LIFTER

- | | | | | | |
|---------------------|----------------------------------|-----------|--------------|-----------------------------|--|
| 184005..... | Machine Mounting Bracket | Semi-Dep. | 184009..... | Auxiliary Foot Lifter Lever | |
| 184002..... | Auxiliary Foot Lifter Lever | | | Chain Screw | |
| 391001..... | Auxiliary Foot Lifter Lever | | 184010..... | Auxiliary Foot Lifter Lever | |
| | Spring | | | Chain Screw Lock Washer, | |
| 1/4"-20x1 5/8"..... | Auxiliary Foot Lifter Lever | | | External Tooth | |
| | Screw | | 184011..... | Auxiliary Foot Lifter Lever | |
| 1/4"-20..... | Auxiliary Foot Lifter Lever | | | Chain Screw Lock Washer, | |
| | Screw Nut | | | Internal Tooth | |
| MET 5965..... | S-Hooks (3) | | 184012..... | Machine Mounting Screws (2) | |
| MET 705-1..... | Auxiliary Foot Lifter Chain | | 184013..... | Machine Mounting Screw | |
| MET 704..... | Foot Treadle | | | Grommets (2) | |
| MET 705..... | Foot Treadle Chain | | MET 123..... | Machine Mounting Tension | |
| MET 8081-3..... | Auxiliary Foot Lifter Lever Stop | | | Springs (2) | |
| #12-1 1/4"..... | Auxiliary Foot Lifter Lever Stop | | 431042..... | Auxiliary Foot Lifter Lever | |
| | Screw | | | Chain Screw Nut | |
| 1/4"-20x3/4"..... | Foot Treadle Screw with Nut (2) | | | | |

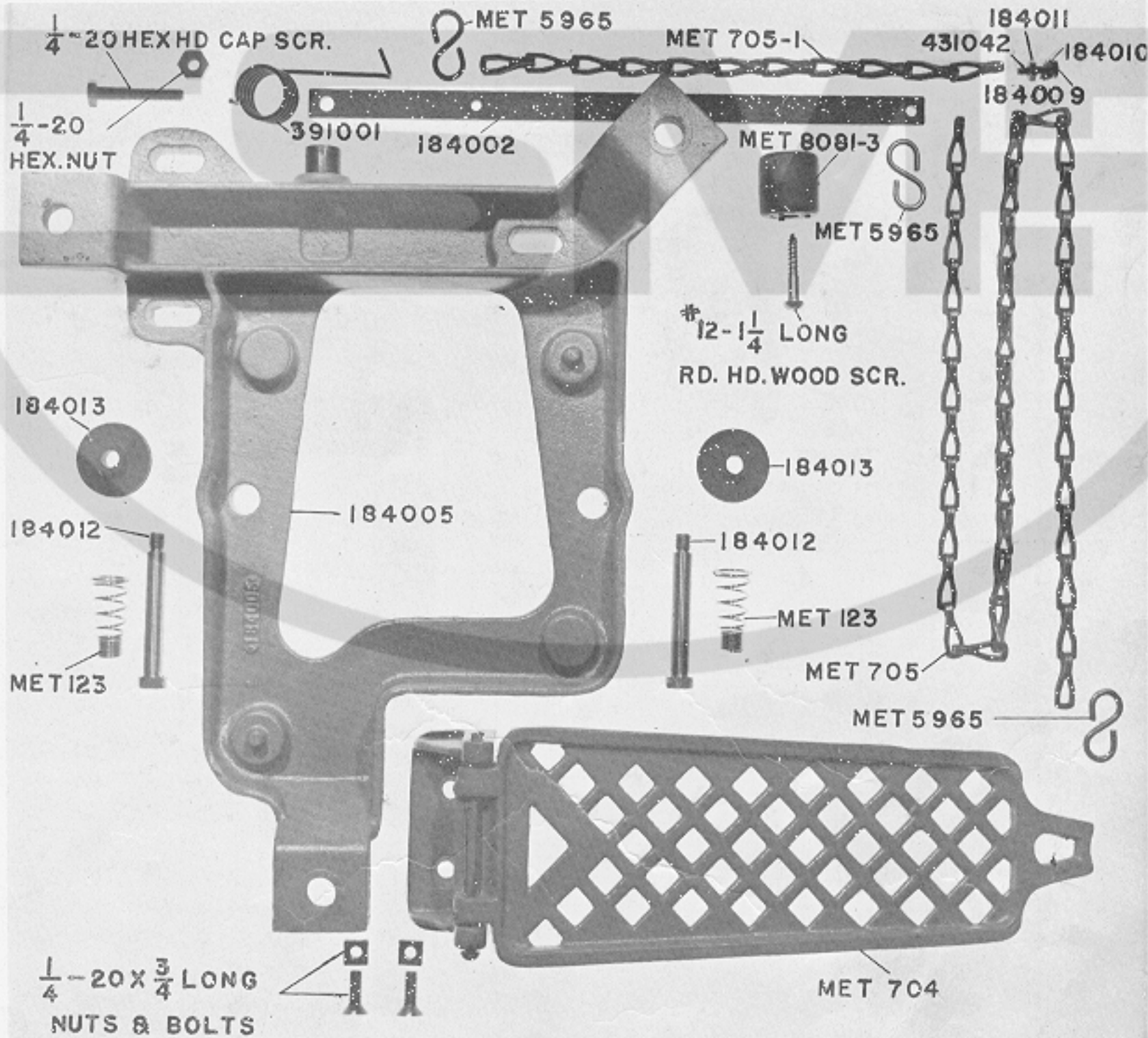

MET.233 D358

MET.233 D358

D354 D353

D358 MET.221

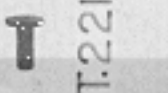

181018

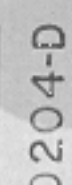
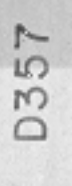
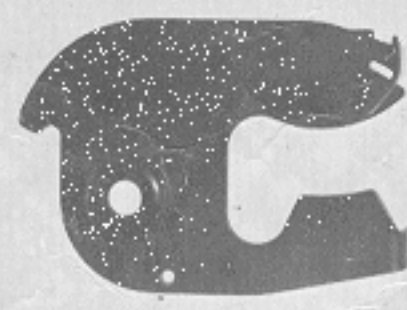

D171-S

D340-1

D206-S

D203 D357 D204-D

D206-W

MET.BI95

10005-A

(3) 4185



D206-1

D206-1

D206-C-1 D355-1

MET.BI95

(3) 4186

4 MET 181



MET.233 D358 D355

D204-4

D204-S

D204-5

MET.BI95

(3) 411016 D216-4

(3) 4185

(3) 4343



MET.233 D358 D355

D215-2

D221-3

D221-S

D216-5

(6) 60286

(3) 2637

(3) D209-1



(3) 2637

(3) D209-1

THREAD HANDLING PARTS

D216-5.....	Thread Tension Guide	MET 233.....	Primary Looper Thread Adjustable Guide Screw
D216-4.....	Thread Tension Guide Plate	D358.....	Primary Looper Thread Adjust- able Guide Screw Washer
4185.....	Tension Nuts (3)	D355-1.....	Primary Looper Thread Auxiliary Guide
4343.....	Tension Nut Stop Pins (3)	MET 181.....	Primary Looper Thread Auxiliary Guide Screw
4186.....	Tension Studs (3)	D206-S.....	Thread Take-Up Screw
411016.....	Tension Springs (3)	D206-W.....	Thread Take-Up Screw Lock Washer
60286.....	Tension Washers (6)	D340-1.....	Needle Thread Guide No. 2
2637.....	Tension Stud Screws (3)	D171-S.....	Needle Thread Guide Screw
D209-1.....	Tension Adapter (3)	D354.....	Needle Thread Loop Controller
D204-4.....	Take-Up Thread Guide, Left	MET 233.....	Needle Thread Loop Controller Screw
D204-5.....	Take-Up Thread Guide, Right	D358.....	Needle Thread Loop Controller Screw Washer
D204-D.....	Take-Up Thread Guide Block	D353.....	Needle Thread Take-Up Thread Guide
MET B195.....	Take-Up Thread Guide Clamp Screws (2)	MET 221.....	Needle Thread Take-Up Thread Guide Screw
D203.....	Take-Up Thread Guide Screw	D358.....	Needle Thread Take-Up Guide Screw Washer
D357.....	Take-Up Thread Guide Screw Washer	D42-C.....	Needle Arm Crank Cover
D204-S.....	Take-Up Thread Guide Spacer	MET 199.....	Needle Arm Crank Cover Screws (2)
D206-1.....	Thread Take-Up	181018.....	Work Guard
D206-C-1.....	Thread Take-Up Opening Cover		
10005-A.....	Thread Take-Up Opening Cover Screw		
D215-2.....	Primary Looper Eyelet Slide		
D221-3.....	Primary Looper Eyelet Slide Spring		
D221-S.....	Primary Looper Eyelet Slide Spring Screw		
D355.....	Primary Looper Thread Adjustable Guide		

"SUPERLOCK" MACHINE

THREAD STAND & SCRAP CHUTES

- | | | | |
|--------------|--|------------------|---|
| D2503-4..... | Scrap Chute, Long | MET 819-3-G..... | Spool Holder |
| D2502-1..... | Work Guard | MET 806..... | Spool Holder Set Screw |
| 181108..... | Cover (Incl. D231, D232, D233,
D234, 181109, 4826 [4]) | 184001..... | Thread Stand Extension Rod,
Lower |
| D2505..... | Thread Stand, Complete (Incl.
D2505-A, 184001, MET 808,
MET 819-3-G, MET 307-PL
[3], MET 803-2 [3]) | MET 808..... | Thread Stand Extension Rod,
Upper |
| D2505-A..... | Thread Stand Base | MET 800-2..... | Thread Stand Extension Rod
Nuts (2), Upper |
| | | MET 307-PL..... | Thread Stand Spool Pins (3) |
| | | MET 803-2..... | Thread Stand Wires (3) |

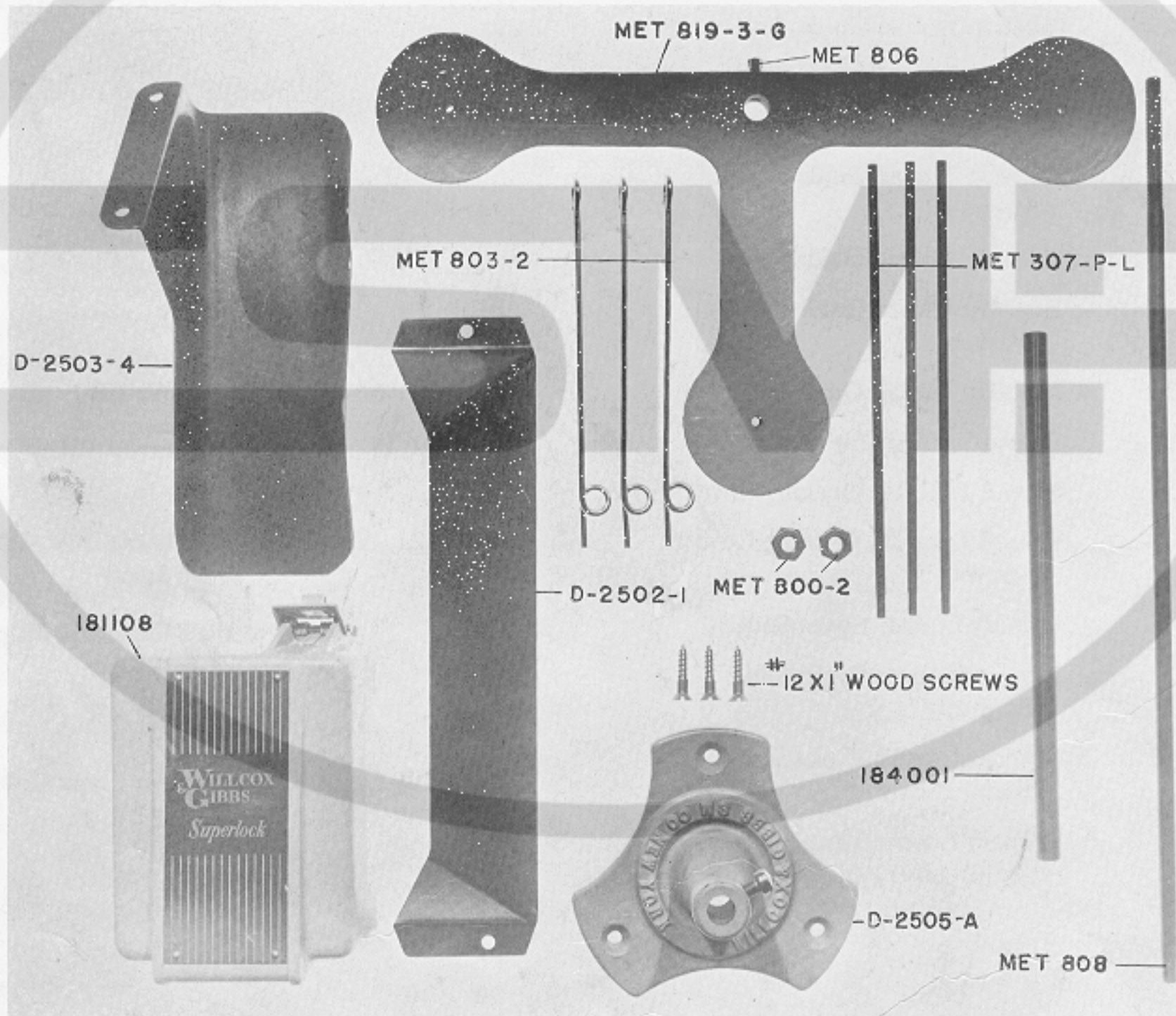

SLIDE-OUT SHIRRING ATTACHMENT

- | | | | |
|-------------------|---|------------------|--|
| 183017..... | Slide-out Shirring Attachment Complete,
(Incl. 183008, 183018, 183019, 183020, MET 4110-5-S, MET 4110-5-S-B, MET 30022, MET 4110-5-S-P, MET 130 [2], MET 155 [3], 2617 [2], 2640 [2], 1325 [2], MET 155-1) | MET 30022..... | Shirring Attachment Shaft Collar |
| 183008..... | Shirring Blade Lifter Lever | MET 4110-5-S-P.. | Shirring Attachment Block Shaft |
| 183018..... | Guide Plate | MET 130..... | Shirring Attachment Block Screws (2) |
| 183019..... | Shirring Attachment Slide | MET 155..... | Shirring Blade Screws (2) |
| 183020..... | Shirring Blade | 2617..... | Shirring Attachment Slide Screws (2) |
| MET 4110-5-S-B.. | Shirring Attachment Block | 2640..... | Shirring Attachment Slide Washers (2) |
| MET 4110-5-S..... | Shirring Attachment Spring | 1325..... | Shirring Attachment Slide Spring Washers (2) |
| | | MET 155..... | Shirring Blade Lifter Lever Screw |
| | | MET 155-1..... | Shirring Attachment Block Shaft Collar Screw |

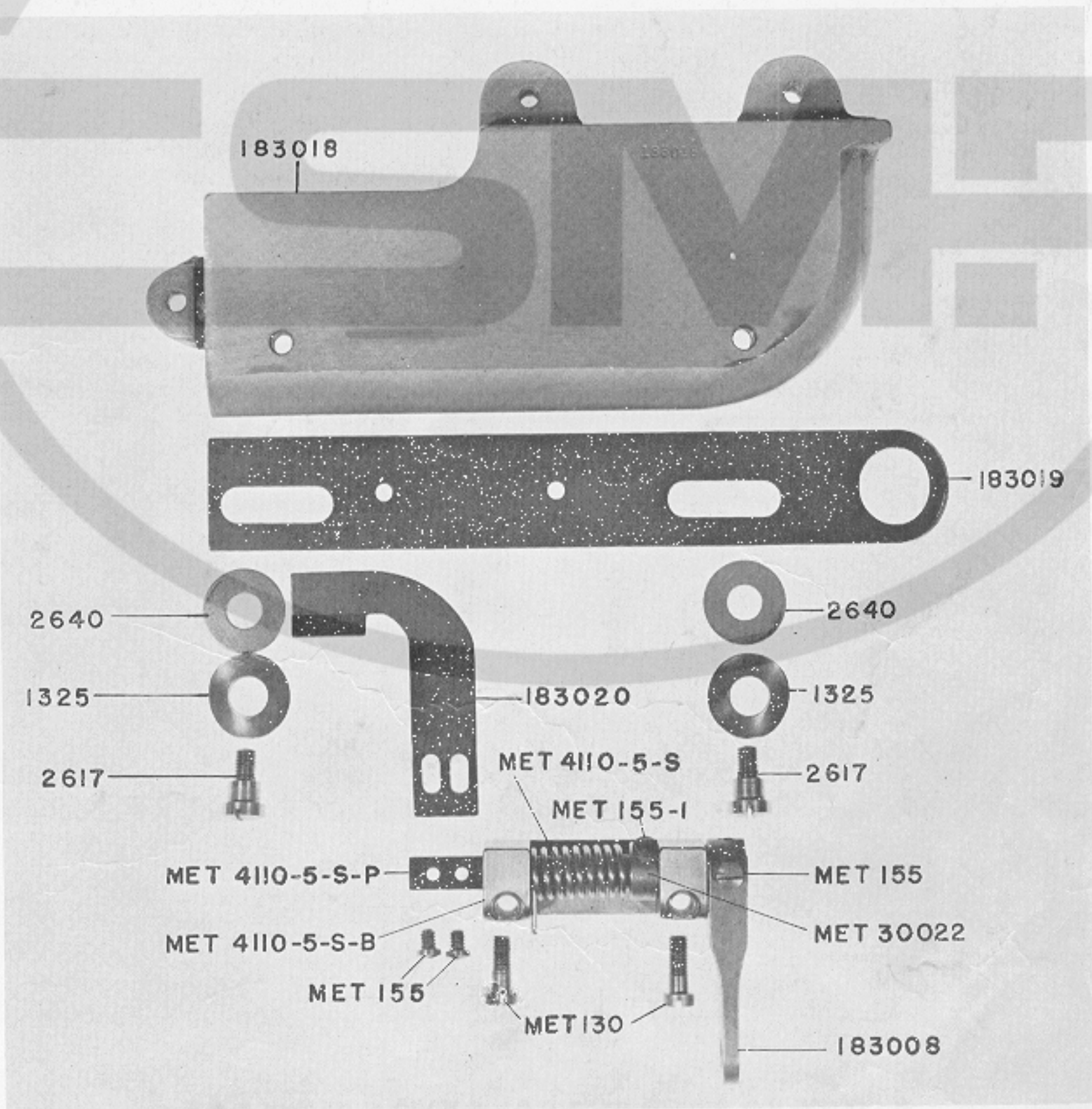

"SUPERLOCK" MACHINE

STATIONARY SHIRRING ATTACHMENT

- 183005.....Stationary Shirring Attachment Complete (Incl. 183006, 183008, 183007, MET 4110-5-SP, MET 155 [3], MET 4110-5-SB, MET 4110-5-S, MET 30022, MET 186, MET 155-1)
- 183006.....Guide Plate
- 183007.....Shirring Blade

- 183008.....Shirring Blade Lifter Lever
- MET 155.....Shirring Blade Lifter Lever Screw
- MET 186.....Shirring Attachment Block Screws (2)
- MET 4110-5-SB.....Shirring Attachment Block
- MET 4110-5-S.....Shirring Attachment Spring
- MET 30022.....Shirring Attachment Shaft Collar
- MET 155.....Shirring Blade Screws (2)
- MET 4110-5-SP.....Shirring Attachment Block Shaft

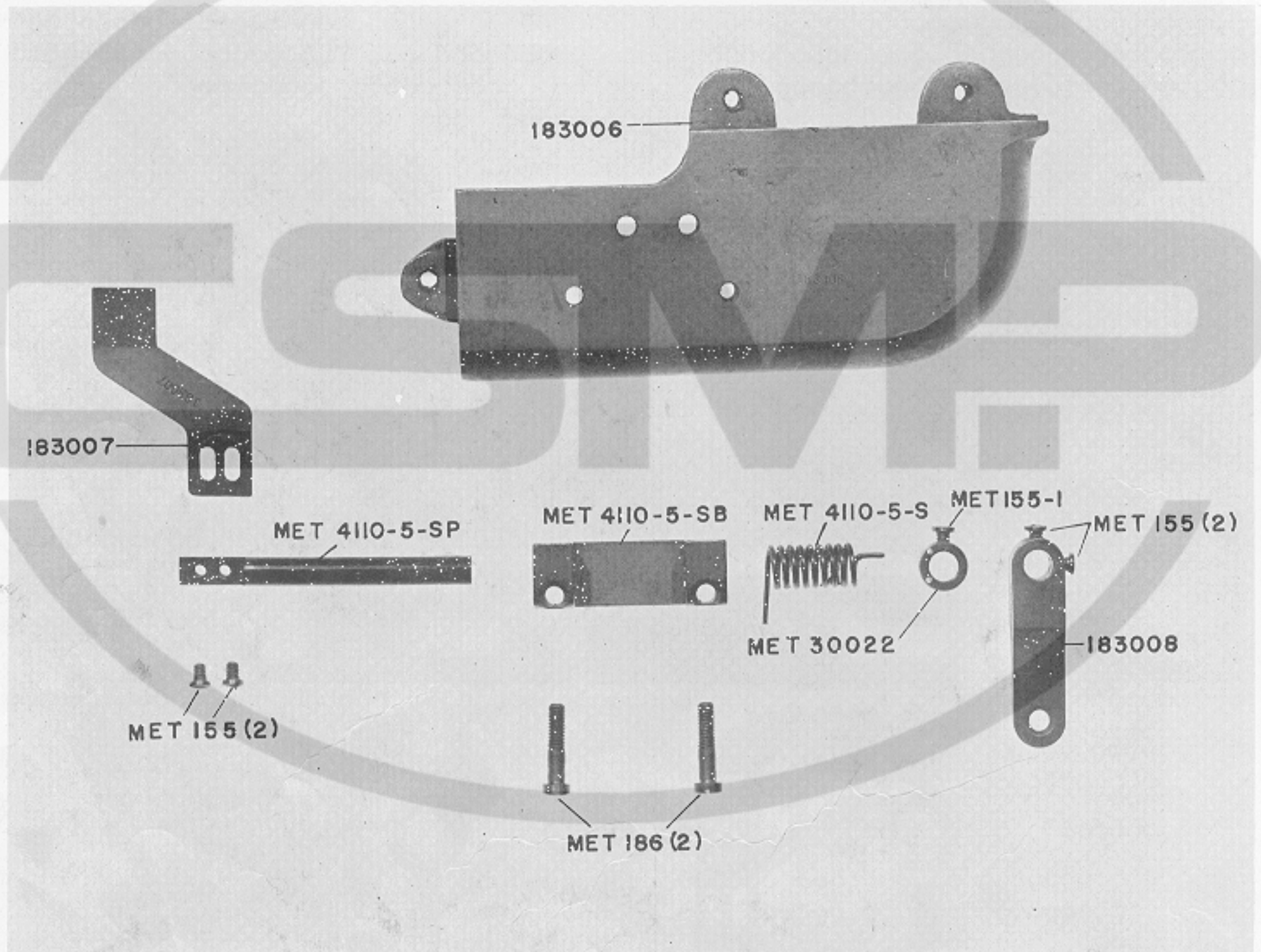

D63-2-1

MACHINE BASE

181077.....Base (Incl. 658, 181045, 181075,
D1-1D, D1-1E, D4, D4-2, D8,
D46 (2), D159 (2), MET 57
(2), MET 5092-1, D146-1
(Plain Feed) or D146-2
(Differential Feed)

MET 8081-3.....Base Cushion Plugs (4)

D4.....Base Gasket

D4-2.....Base Gasket—Small

181047.....Base Gasket Spacer (Not illus.)

D1-1D.....Base Oil Drain Gasket

D1-1E.....Base Oil Drain Screw

D14.....Frame Check Stud

MET 28.....Frame Check Stud Nut

MET 39-1.....Frame Check Stud Nut Washer

MET 9007-7.....Frame Hinge Screws (2)

MET 8008-L.....Frame Hinge Set Screws (2)
(Not illus.)

MET 8750.....Frame Hinge Set Screw Plugs (2)
(Not illus.)

D8.....Frame Latch Stud

181045.....Frame Latch

MET 5092-1.....Frame Latch Spring (Not illus.)

181087.....Base Window Reflector

181080.....Oil Filter

181085.....Oil Strainer

181076.....Oil Pump Cover

MET 61.....Oil Pump Cover Screws (4)

D191-1.....Oil Pump Outlet Gasket—Short

D194.....Oil Relief Valve Adjusting Screw

1166.....Oil Relief Valve Adjusting Screw
Lock Nut

D194-A.....Oil Relief Valve Plunger

D194-B.....Oil Relief Valve Plunger Spring

181082.....Oil Pump Intake Gasket

D147-2.....Differential Lever Rocker

D145-W.....Differential Operating Lever
Screw Lock Washer

MET 56.....Differential Operating Lever
Screw

181086.....Base Window

D155-1.....Differential Operating Lever
Stop Screws (2)

D154.....Differential Operating Lever
Stop Screw Spring

MET 152.....Differential Operating Lever
Spring

D159.....Differential Operating Lever
Spring Stud

D145-2.....Differential Operating Lever

D46.....Differential Operating Lever
Spring Stud Nut

181063.....Oil Pump Pulley

FOLLOWING PARTS FOR USE ON PLAIN
FEED MACHINES ONLY, PARTS ARE NOT
ILLUSTRATED

D146-1.....Base Bushing Oil Plug

MET 229.....Base Stud Hole Plug Screw

MET H28-R.....Base Stud Hole Plug Nut

MET 222.....Base Stud Hole Plug Washer

SWING-OUT SHIRRING ATTACHMENT

183012.....	Swing-Out Shirring Attachment Complete, (Incl. 183013, MET 4110-5-S-B, MET 4110-5-S, MET 30022, 183007, 183008, 183014, MET 186, MET B906, MET 96 [2], 183015, MET 155 [3], D356-W, MET 155-1)	183014.....	Shirring Attachment Block Shaft
183007.....	Shirring Blade	183015.....	Shirring Attachment Block Stop and Blade Lifter
MET 155.....	Shirring Blade Screws (2)	MET 96.....	Shirring Attachment Block Stop and Blade Lifter Screws (2)
183008.....	Shirring Blade Lifter Lever	MET 30022.....	Shirring Attachment Shaft Collar
MET 155.....	Shirring Blade Lifter Lever Screw	MET 155-1.....	Shirring Attachment Shaft Collar Screw
183013.....	Guide Plate	MET 186.....	Shirring Attachment Block Screw
		MET 4110-5-S-B.....	Shirring Attachment Block
		MET 4110-5-S.....	Shirring Attachment Spring
		MET B906.....	Shirring Attachment Block Screw Lock Nut
		D356-W.....	Shirring Attachment Block Screw Lock Washer

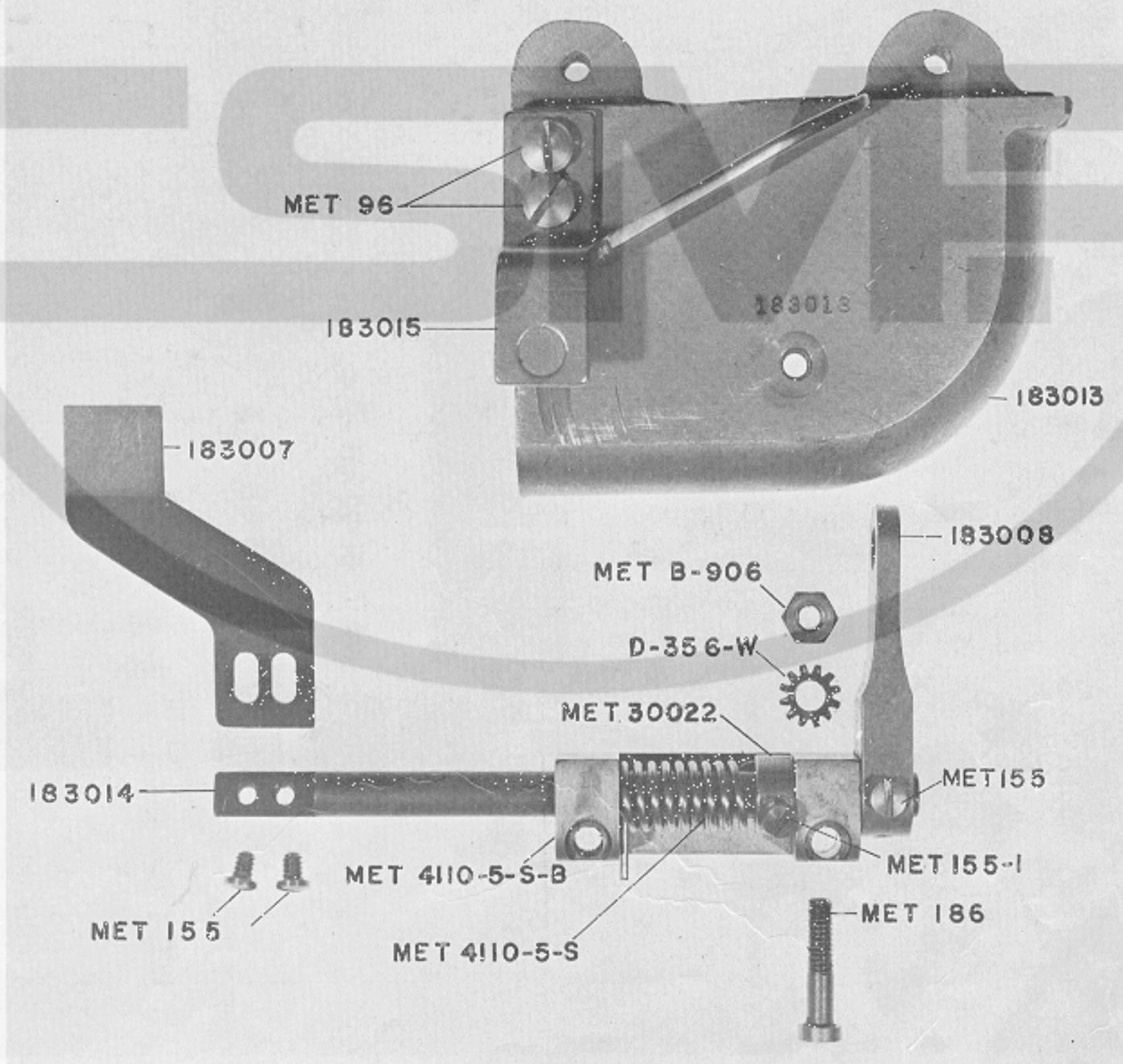

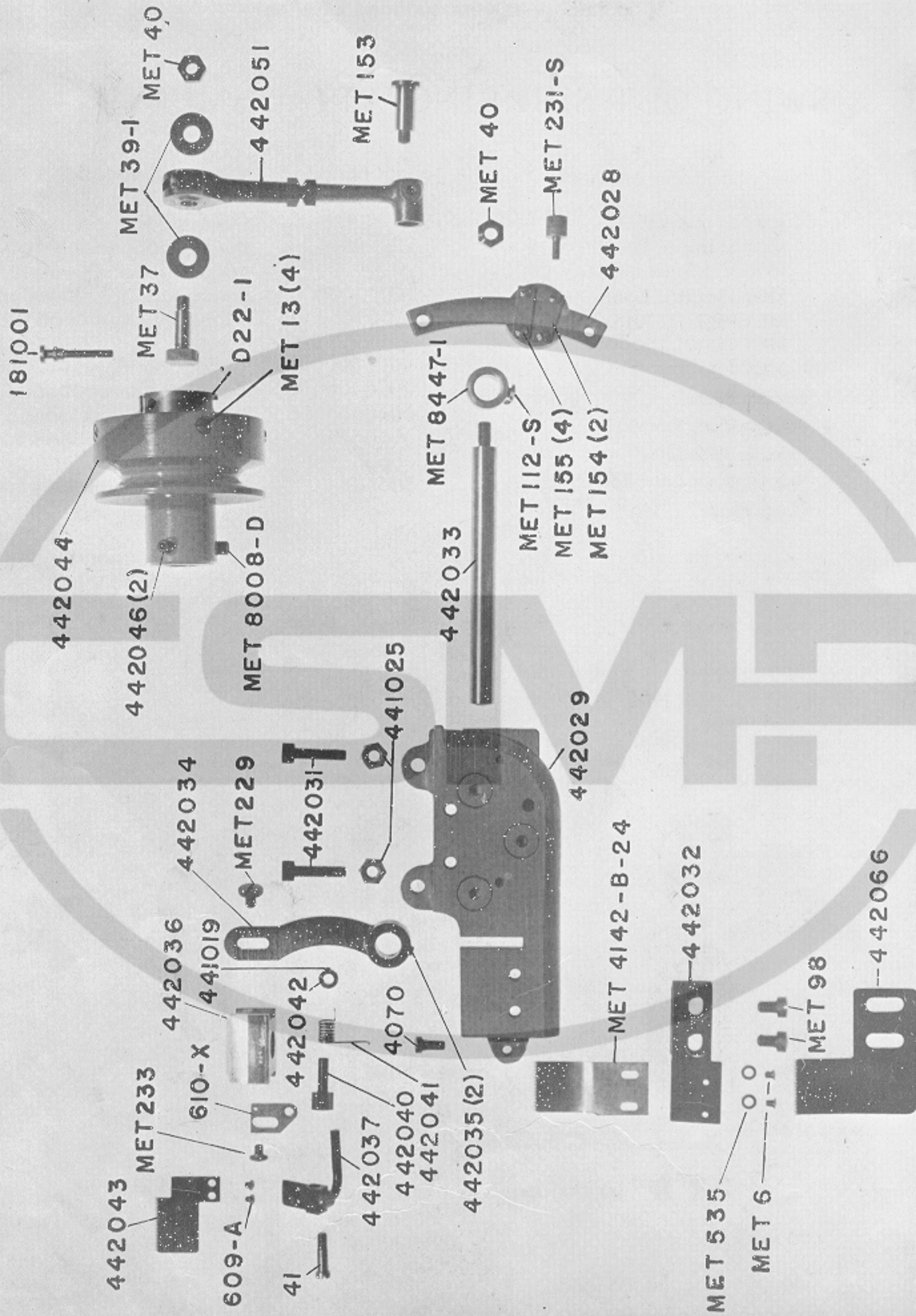

TOP RUFFLER PARTS

442029.....	Top Ruffling Guide Plate	442032.....	Stripper Blade Bracket
442033.....	Ruffling Arm Shaft	MET 535.....	Stripper Blade Screw Washers (2)
MET 8447-1.....	Ruffling Arm Shaft Collar	MET 6.....	Stripper Blade Screws (2)
442028.....	Ruffling Segment Slide	MET 98.....	Stripper Blade Bracket Screws (2)
MET 231-S.....	Ruffling Segment Slide Screw	442066.....	Stripper Blade
MET 40.....	Ruffling Arm Shaft Nut	442043.....	Ruffling Blade
442051.....	Ruffling Regulating Connection Complete	609-A.....	Ruffling Blade Screws (2)
MET 153.....	Ruffling Segment Clamp Screw	MET 223.....	Ruffling Blade Adjusting Plate Screw
MET 39-1.....	Ruffling Regulating Connection Stud Washers (2)	610-X.....	Ruffling Blade Adjusting Plate
MET 40.....	Ruffling Regulating Connection Stud Lock Nut	442042.....	Ruffling Blade Holder Spring Collar
442044.....	Main Shaft Pulley	442041.....	Ruffling Blade Holder Spring
442046.....	Main Shaft Pulley Set Screws (2)	442040.....	Ruffling Blade Holder Spring Post
MET 8008-D.....	Main Shaft Pulley Set Screw	442037.....	Ruffling Blade Holder
D22-1.....	Ruffling Regulating Disc	41.....	Ruffling Blade Holder Screw
MET 13.....	Main Shaft Pulley Disc Screws (4)	MET 112-S.....	Ruffling Arm Shaft Collar Screw
MET 37.....	Ruffling Regulating Connection Binding Stud	MET 154.....	Ruffling Segment Slide Straps (2)
181001.....	Ruffling Regulating Screw	MET 155.....	Ruffling Segment Slide Strap Screws (4)
442036.....	Ruffling Arm Block	441019.....	Ruffling Blade Holder Spring Collar Screw
442034.....	Ruffling Arm	MET 56.....	Ruffling Arm Binding Screw (Not illus.)
MET 229.....	Ruffling Arm Block Screw	442035.....	Ruffling Arm Set Screws (2)
442031.....	Guide Plate Screws (2) Rear		
441025.....	Guide Plate Nuts (2) Rear		
4070.....	Guide Plate Screw, Left		
MET 4142-B-24.....	Stripper Blade		

"SUPERLOCK" MACHINE

MISCELLANEOUS PARTS

(NOT ILLUSTRATED)

182037.....	Chain Cutter for Swing-Out Foot Carrier	D395.....	Hemmer Guide
D290-16-1.....	Chaining Finger (Adjustable Collarete on Knit Goods)	D383.....	Hemmer Guide No. 2
D290-16-8.....	Chaining Finger (Edging Hand- kerchiefs and Curtains)	Group 0-4.....	Knee, Differential Feed Control
SL116.....	Cording and Piping Attachment	D397.....	Knee, Hem Guide Control (Hemmer with Hem Guide Control) (Incl. D365-2, 4070 [3], D387, D388, D372, 1168 [2], 4240, 7623, 203 [2], 3209 [2], D392, D384, 3316, D390 [2], 2094 [2], 243, 246, 249 [3], 244, D379, 241-A, 241-B, 241-C, 247, 248, 4238, M705)
D364.....	Differential Segment Connection	D405.....	Knot Catcher
D382-2.....	Edge Guide Arm	D220-6.....	Lower Blade Holder Plunger, Long
D382-3.....	Edge Guide Pivot Plate	D220-7.....	Lower Blade Holder Plunger (for Hemming Handkerchiefs)
D382-1.....	Edge Guide, Swing-Out Adjustable	D42-D.....	Needle Arm Crank Cover (for Hemmer with Foot or Knee Hem Guide Control)
D9-1.....	Feed Surface Shank Cover (Specify Type Machine When Ordering)	D353-1.....	Needle Thread Take-Up Auxiliary Guide (for Box Edge Stitch Type 505)
D9-C.....	Feed Surface Shank Cover Gasket	D353-2.....	Needle Thread Take-Up Thread Guide
D9-S.....	Feed Surface Shank Cover Screws (2)	D221-1.....	Primary Looper Eyelet Slide Spring (Wide Trim)
181004.....	Feed Surface Shank, Differential Feed, High Lift	181002.....	Secondary Looper Shaft, Lower, High Lift
D396.....	Foot, Hem Guide Control, (Hemmer with Hem Guide Control) (Incl. M704, M705, D365-2, 4070 [3], D387, D388, D372, 1168 [2], 4240, 7623, 202 [2], D389 [2], 3309 [2], D392, D384, 3316, D390 [2], 2049 [2], 4238 [2], 558-A)	181003.....	Secondary Looper Shaft, Upper, High Lift
D290-24.....	Foot Hemmer (Edging Hand- kerchiefs and Curtains)	181026.....	Shirring Blade Lifter
D290-20.....	Foot Shoc Plate 1/4" (Seamer and Closer)	60270.....	Stitch Regulating Connection Complete (Incl. D364, 60269, 181024)
D365-4.....	Guide Plate	D103-3.....	Trimmer Arm Connection Stud, Threaded, (used with D101-1)
D365-2.....	Guide Plate, Hemmer with Hem Guide Control (Incl. 4070 [3])	D368.....	Trimmer Locking Stud
D370.....	Hemmer Gauge, Hinged, Com- plete (Size to be specified)	D250-F.....	Whisker Brush (for Edging Wide Wrap Lace)
D393 or D394.....	Hemmer Gauge (Size to be specified)	D250-G.....	Whisker Brush Rivet
182058.....	Stitch Regulating Stud Bushing (used with Stretching Differential)	182022.....	Secondary Looper for High Lift
181027.....	Foot Carrier Arm Shaft for Blade Lifter	182021.....	Primary Looper for High Lift

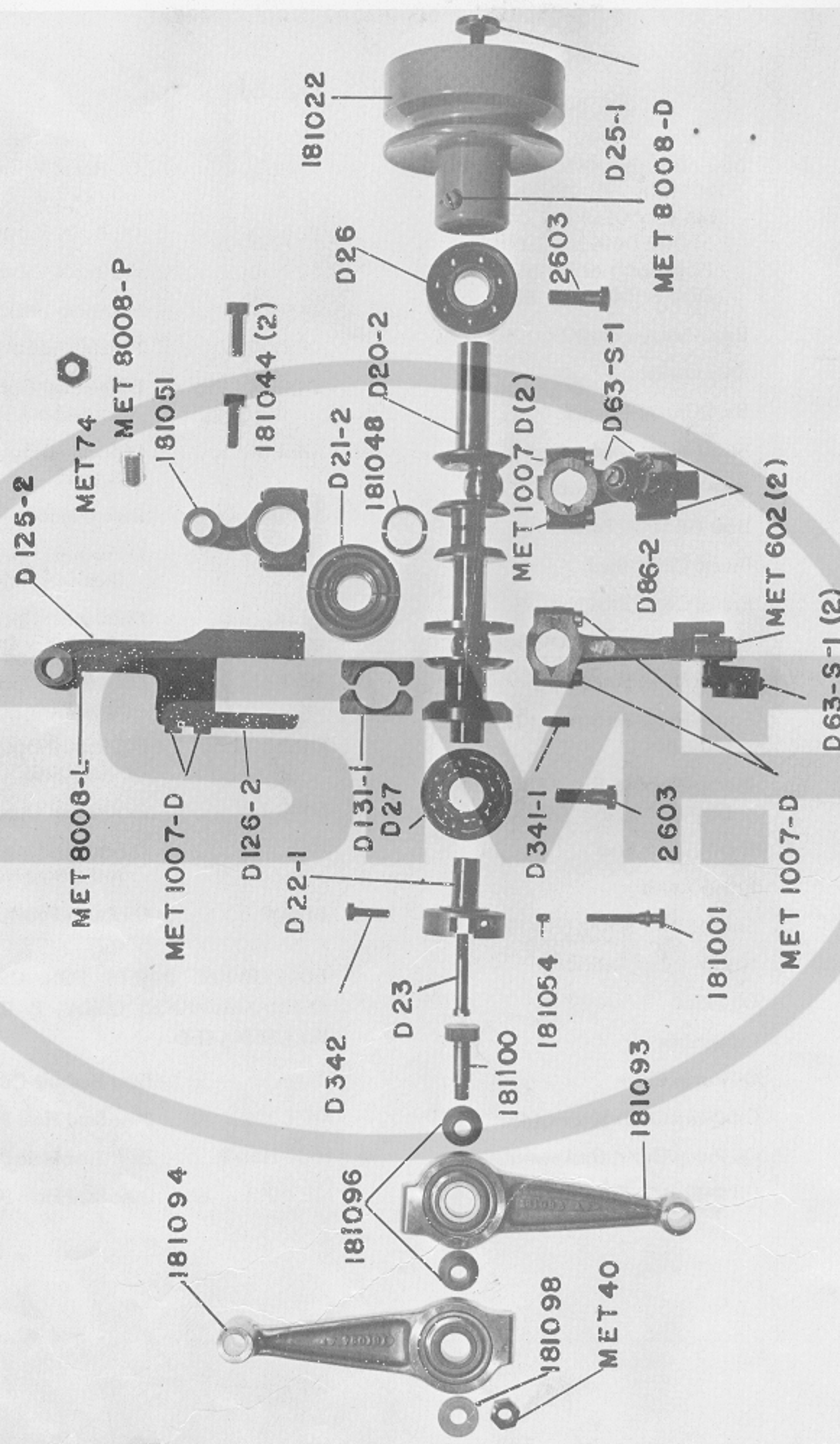

MAIN SHAFT ASSEMBLY

D20-2.....	Main Shaft	MET 1007-D.....	Secondary Looper Crank Connection Cap Screws, Upper (2)
181052.....	Main Shaft Complete (Incl. 181051, D65-3, D86-2, D20-2, 181048)	D63-S-1.....	Secondary Looper Crank Screws (2)
181022.....	Main Shaft Pulley	MET 602.....	Secondary Looper Crank Connection Cap Screws, Lower (2)
D25-1.....	Main Shaft Pulley Center Screw	D131-1.....	Feed Lift Eccentric Block (Pair)
MET 8008-D.....	Main Shaft Pulley Set Screw	D125-2.....	Feed Bar
D26.....	Main Shaft Ball Bearing, Right	MET 8008-L.....	Feed Bar Shaft Screw
2603.....	Main Shaft Ball Bearing Clamp Screws (2)	MET 1007-D.....	Feed Bar Cap Screws (2)
D65-3.....	Primary Looper Crank Connection	D126-2.....	Feed Bar Cap
MET 1007-D.....	Primary Looper Crank Connection Cap Screws, Upper (2)	D341-1.....	Stitch Regulating Disc Set Screw and Spot Screw (2)
MET 602.....	Primary Looper Crank Connection Cap Screws, Lower (2)	D27.....	Main Shaft Ball Bearing, Left
D63-S-1.....	Primary Looper Crank Screws (2)	D22-1.....	Stitch Regulating Disc
181048.....	Needle Arm Crank Connection Split Bearing	D23.....	Stitch Regulating Disc Screw
181051.....	Needle Arm Crank Connection (Incl. 181049, D44-1)	D342.....	Stitch Regulating Limit Screw
D21-1.....	Main Shaft Center Bearing (Incl. 181044 [2])	181054.....	Stitch Regulating Limit Lock Screw
181044.....	Main Shaft Center Bearing Clamp Screws (2)	181001.....	Stitch Regulating Screw
MET 74.....	Main Shaft Center Bearing Lock Nut	181100.....	Stitch Regulating Stud
MET 8008-P.....	Main Shaft Center Bearing Screw	181096.....	Stitch Regulating Stud Bushings (2)
D86-2.....	Secondary Looper Crank Connection	181093.....	Differential Segment Connection
		181094.....	Stitch Regulating Connection
		181098.....	Stitch Regulating Stud Washer
		MET 40.....	Stitch Regulating Stud Nut

13
57

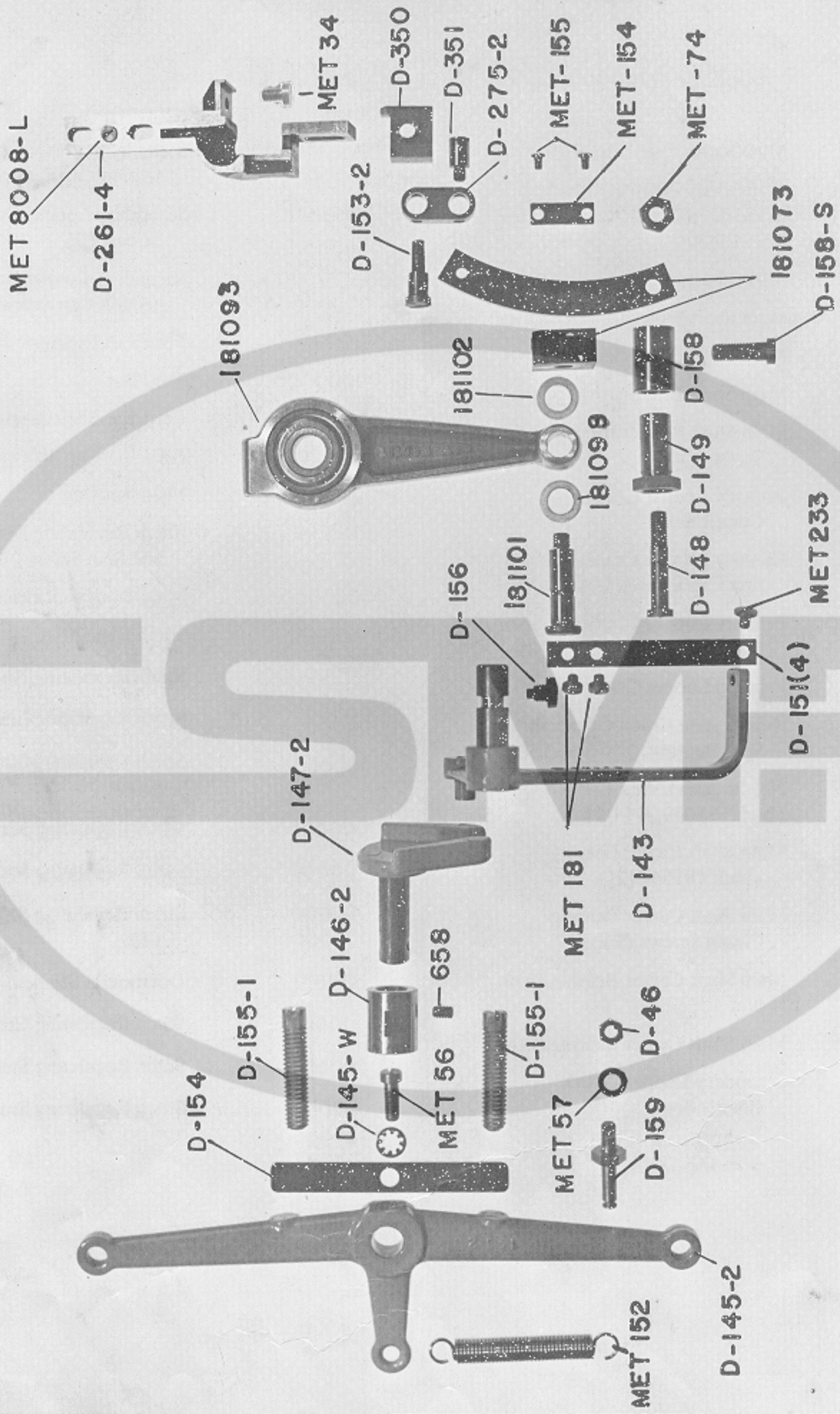

DIFFERENTIAL FEED ASSEMBLY

D261-4.....Feed Surface Shank--Differential Feed Only

MET 8008-L.....Feed Surface Shank Tilt Screw

D350.....Feed Surface, Front, Slide

D275-2.....Feed Surface, Front, Link

D153-2.....Feed Surface, Front, Link Stud

D351.....Differential Segment Stud

MET 154.....Differential Segment Slide Strap

MET 155.....Differential Segment Slide Strap Screws (2)

181073.....Differential Segment Slide, Complete (Incl. 181072, 181074, MET 154, MET 155 [2])

181093.....Differential Segment Connection

181101.....Differential Segment Connection Stud

D148.....Differential Segment Screw

MET 74.....Differential Segment Screw Nut

181102.....Differential Segment Connection Spacer

D149.....Differential Segment Sleeve

D158.....Differential Segment Sleeve Bushing

D158-S.....Differential Segment Sleeve Bushing Clamp Screw

181098.....Differential Segment Connection Stud Washer

D151.....Differential Segment Slide Connection (4)

MET 233.....Differential Segment Slide Connection Screw, Lower

MET 181.....Differential Segment Slide Connection Screws, Upper (2)

D143.....Differential Lever

D147-2.....Differential Lever Rocker

D146-2.....Differential Lever Rocker Shaft Bushing

658.....Differential Lever Rocker Shaft Bushing Set Screw

D156.....Differential Lever Shaft Screw

D145-2.....Differential Operating Lever

MET 56.....Differential Operating Lever Screw

D145-W.....Differential Operating Lever Screw Lock Washer

MET 152.....Differential Operating Lever Spring

D159.....Differential Operating Lever Spring Stud

D46.....Differential Operating Lever Spring Stud Nut

MET 57.....Differential Operating Lever Spring Stud Washer

D155-1.....Differential Operating Lever Stop Screws (2)

D154.....Differential Operating Lever Stop Screw Spring

MET 34.....Feed Surface, Back Screw

NOTE: To change a Plain Feed machine into a Differential Feed machine order Group DF-1 (Not illustrated).

"SUPERLOCK" MACHINE

PRIMARY LOOPER DRIVE

D60-3.....	Primary Looper	D65-3.....	Primary Looper Crank Connection
D66-1.....	Primary Looper Screws (2)	MET 602.....	Primary Looper Crank Connection Cap Screws, Lower (2)
D61-1.....	Primary Looper Shaft	MET 1007-D.....	Primary Looper Crank Connection Cap Screws, Upper (2)
D62-1.....	Primary Looper Shaft Bushing	D64-1.....	Primary Looper Crank Connection Guide
2603.....	Primary Looper Shaft Bushing Clamp Screw	3160.....	Primary Looper Crank Connection Guide Screw
D63.....	Primary Looper Crank (Incl. [2] D63-S-1)		
D63-S-1.....	Primary Looper Crank Screws (2)		

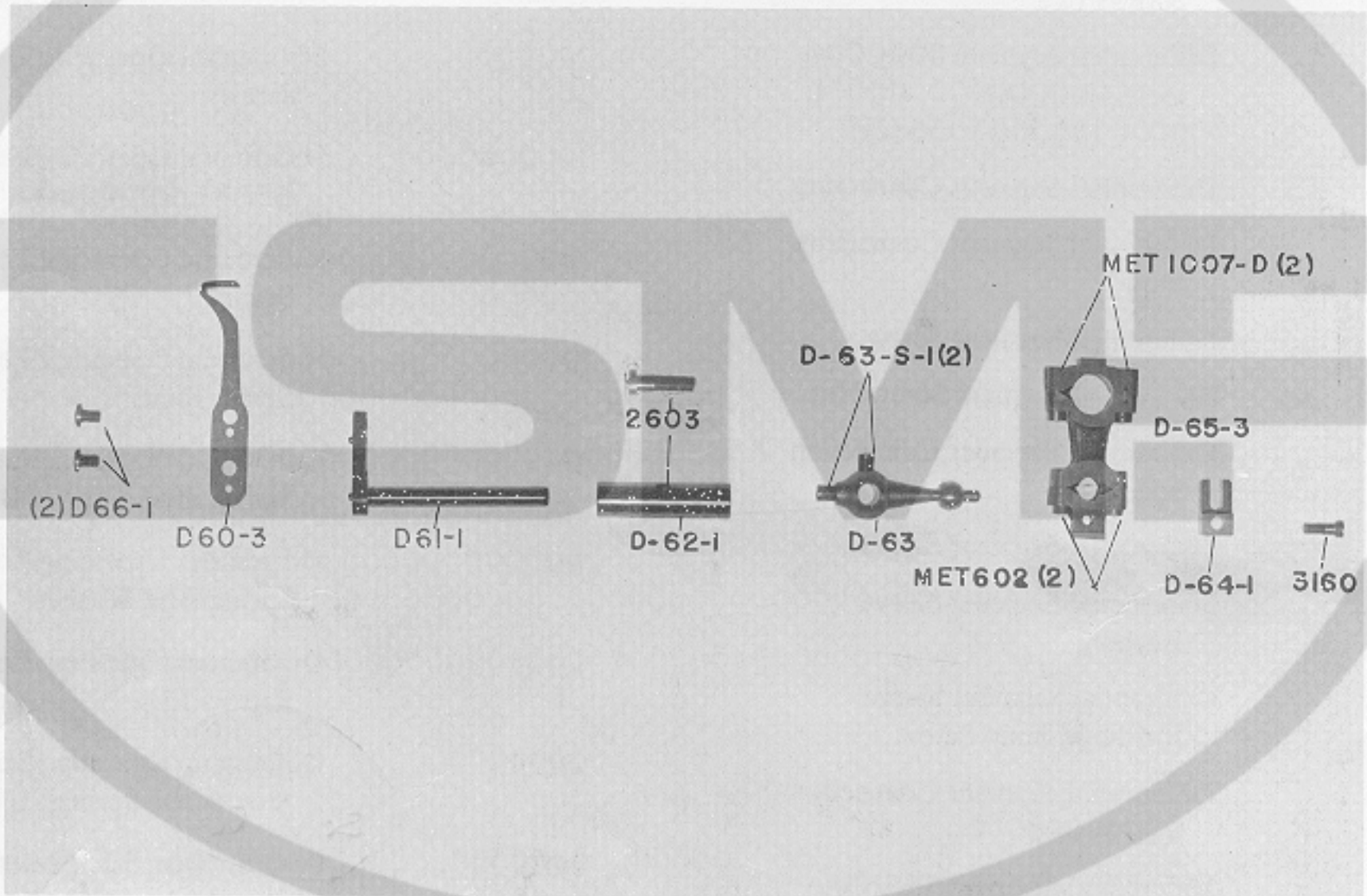

SECONDARY LOOPER DRIVE

D85.....	Secondary Looper Crank	181056.....	Secondary Looper Shaft, Lower
D86-2.....	Secondary Looper Crank Connection	181057.....	Secondary Looper Shaft, Upper
MET 602.....	Secondary Looper Crank Connection Cap Screws, Lower (2)	181059.....	Secondary Looper Shaft Bushing, Lower
MET 1007-D.....	Secondary Looper Crank Connection Cap Screws, Upper (2)	D93-1.....	Secondary Looper Shaft Bushing, Lower Set Screws (2)
D64-1.....	Secondary Looper Crank Connection Guide	181058.....	Secondary Looper Shaft Bushing, Upper
3160.....	Secondary Looper Crank Connection Guide Screw	D93-2.....	Secondary Looper Shaft Bushing, Upper Set Screws (2)
D63-S-1.....	Secondary Looper Crank Screws (2)	D67-2.....	Secondary Looper Shaft Retainer
4101.....	Secondary Looper Screws (2)	MET 96.....	Secondary Looper Shaft Retainer Screws (2)
		D80-4.....	Secondary Looper

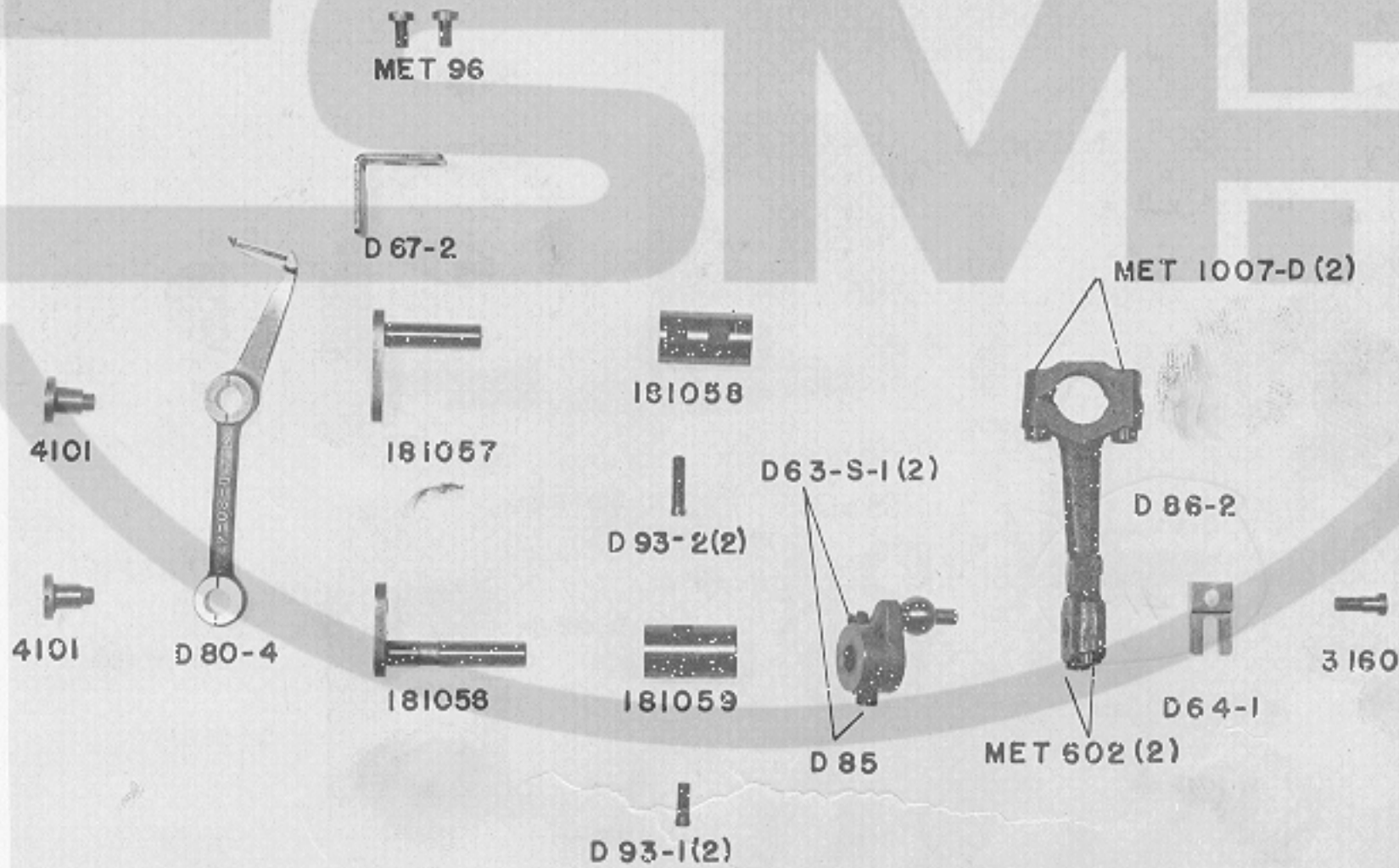

"SUPERLOCK" MACHINE

NEEDLE ARM ASSEMBLY

D40-6	Needle Arm Bracket	181048	Needle Arm Crank Connection Split Bearing
D50-3	Needle Arm Bracket Gasket—Large	D44-2	Needle Arm Crank Connection Bushing
D50-1	Needle Arm Bracket Gasket—Small	D52-1	Needle Arm Crank Connection Bushing Screw
D51	Needle Arm End Gasket	D145-W	Needle Arm Crank Connection Bushing Screw Lock Washer
D40-S	Needle Arm Bracket Screws (4)	D40-P	Needle Arm Bracket Steady Pins (2)
D356-1	Needle Arm Bracket Shield	D101-1	Trimmer Arm Connection
D356-W	Needle Arm Bracket Shield Screw Lock Washers (2)	181091	Needle Arm Retaining Washer
MET 233	Needle Arm Bracket Shield Screws (2)	181092	Needle Arm
D42-2	Needle Arm Crank	D47	Needle Clamp Washer
MET 56	Needle Arm Crank Clamp Screw	D46	Needle Clamp Nut
181054	Needle Arm Adjusting Screws (2)	D45	Needle Clamp Screw
181051	Needle Arm Crank Connection		
MET 1007-D	Needle Arm Crank Connection Cap Screws (2)		

